

MAJORITY

SKIDDAW II

Wireless Audio Soundbar

SKD-BAR-BLK-2



Instructions Guide

Contents

Controls And Functions	1
What's In The Box?	5
Support	6
Instructions Guide	7
Fixing the Soundbar	7
Mode Indicator Lights.....	8
Using the AUX Connection.....	9
Using the Optical Input	10
Using the MP3 LINK Connection (Line In).....	11
Connecting to the Mains Supply.....	12
Bluetooth Operation.....	13
Troubleshooting	15
Specifications	16
Warranty	16
Safety Information	17

**3 YEAR
WARRANTY**

Watch video tutorials and register
your product for a FREE 3-year warranty
at www.majorityradios.co.uk

Front View/LED Indicator Light



1. Speaker Drivers
2. Remote Control Sensor
3. LED Indicator Light

Side View: Buttons

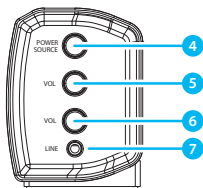

4. Press and hold for 3 seconds to switch on/off the unit. Press to switch between Bluetooth, AUX & RCA) in, LINE in or OPTICAL in.
5. Volume increase
6. Volume decrease
7. 3.5mm stereo LINE in

Rear View: Panel Interface Connection

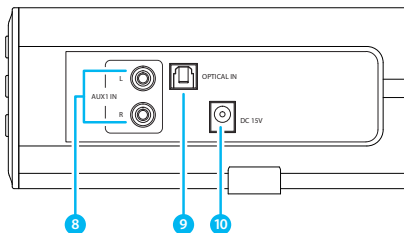

8. AUX (RCA) Socket
9. OPTICAL In Socket
10. DC 15V 1.5A Socket

Automatic Power Off Function

The Majority Skiddaw will automatically go to standby mode after 60 minutes in the TV of external unit is discontinued or switched off.

Remote Control

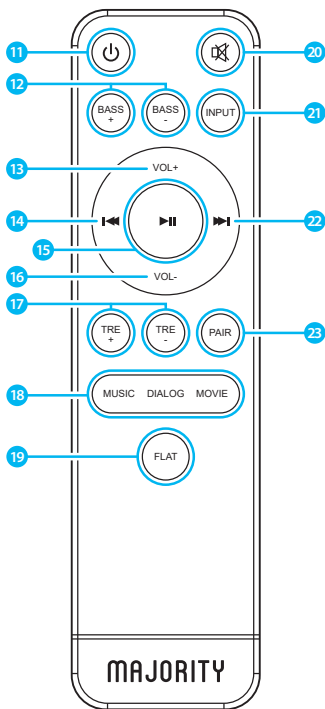

- 11. Power On/Off**
Switch the unit between on and Standby mode
- 12. Bass increase/decrease**
Select to adjust the bass
- 13. Volume +**
Press to increase the volume
- 14. Back Step**
Use in Bluetooth mode to go back a track.
- 15. Play/Pause**
In Bluetooth mode, press to pause/play media.
- 16. Volume -**
Press to decrease the volume
- 17. Treble increase/decrease**
Select to adjust the treble
- 18. Media Modes: Music, Dialogue or Movie**
Press relevant button for the media type for the best sound quality
- 19. FLAT**
Press button to restore to default sound settings.

20. MUTE

Press to mute and unmute sound.

21. INPUT

Press repeatedly to switch between modes

22. Forward Step

Use in Bluetooth mode to go forward a track.

23. PAIR

In Bluetooth mode, press to pair with your device. Press again to disconnect.

Using the Remote Control

The remote control sensor at the front of the soundbar is sensitive to the remote control's commands up to a maximum of 6 metres away and within a maximum arc of 40 degrees.

Please note that the operating distance may vary depending on the brightness of the room.

Box Contents

1. Majority Skiddaw II Soundbar
2. Remote Control
3. Adapter
4. 3.5mm to 3.5mm Audio cable
5. RCA Stereo Audio Cable
6. Wall Bracket
7. Wall fixing and screws
8. Instructions Guide



Majority Skiddaw II Soundbar

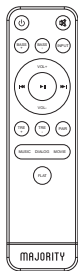

Remote Control

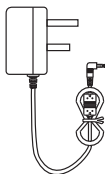

Adapter



3.5mm to 3.5mm Audio Cable



RCA Stereo Audio Cable

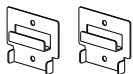

Wall Bracket



Wall fixing and screws



Instruction Manual

Support

Thank you for your purchase of the Majority Skiddaw II.

Please follow the guidance of the manual to set up your soundbar and enjoy its fantastic features.

If you require further assistance with your new soundbar, please contact our support team on the Majority website:

<https://www.majorityradios.co.uk/support/>

Fixing the Soundbar

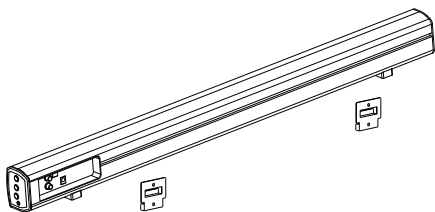
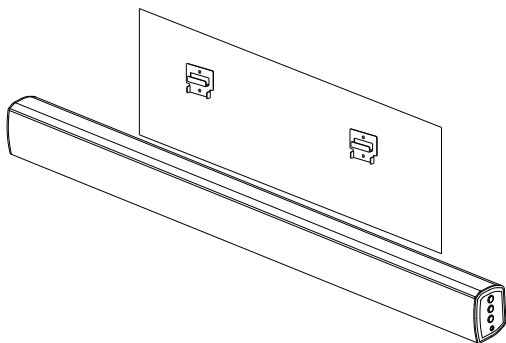

Ensure the TV or Vision Device is placed properly. Turning the volume loud may cause the device to fall down.

Mode Indicator Lights

State	Indicator Lights
Power off	Red
Optical mode	Yellow
AUX mode	White
Line in mode	Green
Bluetooth ready	Flashing blue
Bluetooth connected	Blue

Using the AUX Connection

Use the RCA Stereo Audio Cable to connect the TV's stereo RCA(L/R). Audio output socket to the AUX(L/R) Sockets of the unit.

Then press the INPUT button on the remote control (**Ref.21**) or press the SOURCE button on the unit (**Ref.4**) repeatedly to choose the AUX function. A white light will display once on this mode.

Turn on your television set to use the Majority Skiddaw II.

Please check the ports that the RCA cable are being inputted into on your TV. If the TV ports are 'input' rather than 'output', please use a different process to connect the soundbar to your TV.

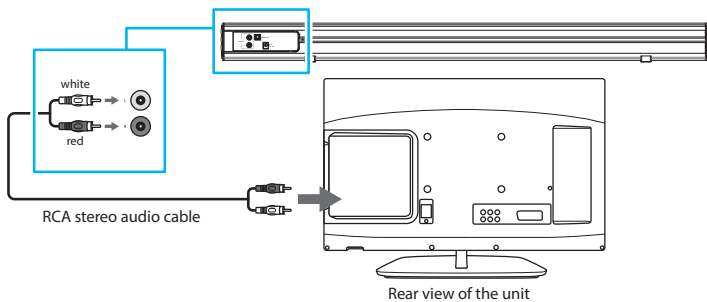

Using the Optical Input

You will need: An audio source with an Optical Audio Output and a Digital Optical Audio cable (not included)

Connect the Digital Optical Audio cable to the optical output on the audio source and to the Optical Input on the speaker bar.

Press the POWER/SOURCE button on side panel (**Ref.4**) or POWER button directly on the remote control (**Ref.11**) to switch on the unit.

Press the INPUT button on the remote control (**Ref.21**) repeatedly to switch to Optical mode or press the POWER/SOURCE button on main unit (**Ref.4**) repeatedly to select the Optical mode. The mode indicator LED will turn Yellow.

Using the native controls on your connected device, make sure the audio settings are set to PCM or Optical Audio and are turned On.

Audio from the connected audio source will now be played through the speakers.

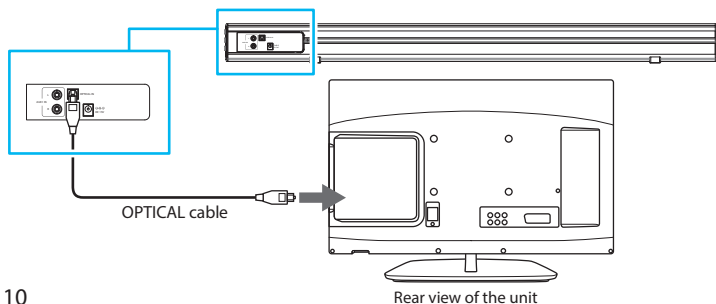

Using the MP3 LINK Connection (Line In)

Plug one end of a 3.5mm audio input cable (included) into the Line in on the unit (**Ref.7**). Before use, disconnect any cables connected to the Stereo RCA Inputs.

Plug the other end of the cable into the audio output/headphone output on an MP3 player or other audio source.

Press the POWER/SOURCE button on side panel (**Ref.4**) or POWER button directly on the remote control (**Ref.11**) to switch on the unit.

Press the POWER/SOURCE button repeatedly or directly press the INPUT button on remote control (**Ref.21**) to enter LINE in mode. The mode indicator will turn green.

Audio played through the connected device will now be heard through the speakers.

Side view of the unit

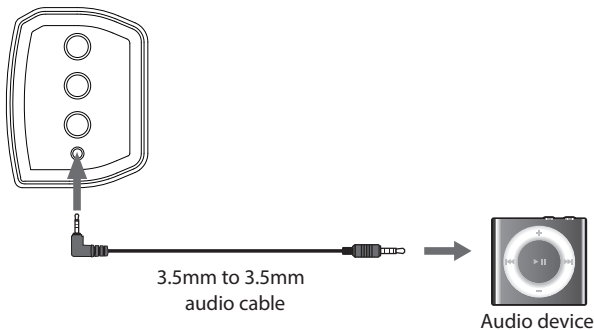

Connecting to the Mains Supply

Ensure that the power supply voltage is in the voltage of 100V~240V.

This unit is designed to use adapter.

Connecting the unit to any other power source may cause damage to the unit.

Unwind the mains cable to its full length. Connect the mains plug to a mains socket. Make sure the mains plug is fully inserted into the mains socket.

The mains plug/appliance coupler is used as the disconnect device, the disconnect device must remain readily operable.

Connect the Adapter to the unit and AC Socket.

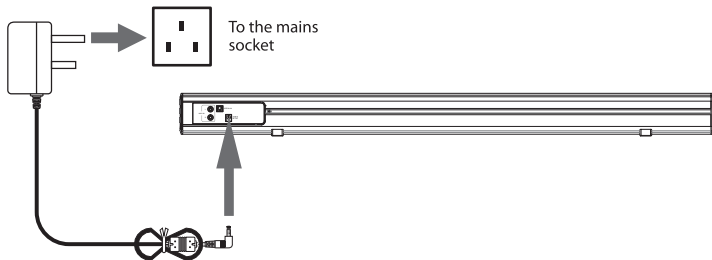

Ensure all audio connections of the unit are connected before connecting to the mains power socket.

Unplug the power cord from the outlet when the unit is use for an extended period of time.

Bluetooth Operation

Pairing a Bluetooth Device for the First Time

Press the POWER/SOURCE button on the unit (**Ref.4**) or the POWER button on the remote control (**Ref.11**) to switch on the unit.

Select and press the INPUT directly on the remote control (**Ref.21**) or press the POWER/SOURCE button repeatedly on the soundbar (**Ref.4**) to enter Bluetooth mode, indicated by a flashing blue light.

Using the native controls on your Bluetooth device, select the "Majority Skiddaw II" in your Bluetooth settings to pair.

If your device requests a password, enter the default "0000". Refer to the "user manual" for your specific device for instructions on pairing and connecting Bluetooth devices.

When successfully paired and connected, a beep will issue from the unit and the Pairing Indicator will display a solid blue light. After initial pairing, the unit will stay paired unless unpaired manually by the user, or until it is erased due to a reset of the device.

If the soundbar is Bluetooth connected to a device, you can press the PAIR button for 3 seconds to exit this device in order to pair the device with another Bluetooth device.

If your device should become unpaired or you find it is unable to connect, repeat the above steps.

Playing Audio Wirelessly

Follow the instructions for Pairing a Bluetooth Device.

Use the native controls on the connected Bluetooth Device to select a track.

To play, pause or skip the selected track, use the native controls on the connected Bluetooth Device.

Audio played through the connected Bluetooth device will now be heard through the speakers.

If the Soundbar does not work properly as desired, please check the following checklist.

Malfunction	Possible causes/measures
No power / function	<p>Check whether the power is switched on or off at the wall.</p> <p>Check whether the power adaptor is properly connected to power outlet or not.</p>
No sound	<p>Check whether unit is set to MUTE or not.</p> <p>Check whether MODE is correctly selected or not.</p> <p>Check whether cables are properly installed or not.</p>
No sound from bluetooth connection	<p>Check whether you have pressed PAIR button before pairing.</p> <p>Check whether external device requires password "0000" to start with.</p>
Function disturbance	<p>Switches off and unplugs the unit. Leaves it for 2 minutes and switches it on again. If a particular mode is causing problems, please try an alternative connection to your TV such as Optical, AUX or Bluetooth.</p>
Remote control does not work [properly]	<p>Check whether the battery has run out or not. Replaces a new one if necessary.</p> <p>Check whether there is obstacle on the front of remote sensor or not.</p>
No sound when connection and switches to OPTICAL IN mode	<p>Check and ensures the audio setting of the input source (e.g. TV, game console, DVD player, etc.) is set to PCM mode while using digital connection (such as Optical, HDMI and COAXIAL)</p>

Specifications

Specifications

Power Supply	DC 15V 1.5A
Frequency Response	30Hz-20KHz
SNR	70dB
Separation	45dB
Bluetooth	V3.0
Dimension (WxHxD)	90.1 x 5.4 x 7.2 cm
Net Weight	1.5kg

Warranty

All products come with a standard 12 month warranty. All items must be registered on www.majorityradios.co.uk for the warranty to be valid. Once on the web page, use the menu to find "Register Your Product". You will also be given the chance to extend your warranty for an additional 24 months, free of charge.

1. **Read these instructions.**
2. Keep these instructions. Instructions are also available for download at www.majorityradios.co.uk
3. Heed all Warnings
4. Follow all instructions
5. Do not clean the apparatus near or with water
6. Do not block any ventilation openings. Install in accordance with the manufacturer's instructions
7. Do not block any ventilation openings. Install in accordance with the manufacturer's instructions.
8. Do not install near any heat sources such as radiators, heat registers, stoves, or other apparatus (including amplifiers) that produce heat.
9. Protect the power from being walked on or pinched particularly at plugs, convenience receptacles, and the point where they exit from the apparatus.
10. Only use attachments/accessories specified by the manufacturer.
11. Unplug this apparatus during light storms or when unused for long periods of time.
12. Refer all servicing to qualified service personnel. Servicing is required when the apparatus has been damaged in a way, such as power-supply cord or plug is damaged, liquid has been spilled or objects have fallen into the apparatus, the apparatus has been exposed to the rain or moisture, does not operate normally or has been dropped.
13. No naked flame sources, such as lit candles, should be placed on the apparatus.
14. Dispose of used electrical products and batteries safely according to your local authority and regulations.

ADDITIONAL WARNINGS

The apparatus shall not be exposed to dripping or splashing and no objects filled with liquid, such as vases, shall be placed on the apparatus. Main plug is used to disconnect device and it should remain readily operable during intended use. In order to disconnect the apparatus from the main mains completely, the mains plug should be disconnected from the main socket outlet completely. Battery shall not be exposed to excessive heat such as sunshine, fire or the like.

RECYCLING ELECTRICAL PRODUCTS

You should now recycle your waste electrical goods and in doing so help the environment.



This symbol means an electrical product should not be disposed of with normal household waste. Please ensure it is taken to a suitable facility for disposal when finished with.

IMPORTANT: Please read all instructions carefully before use and keep for future reference.



Risk of electric shock.
Do not open



Read all instructions carefully before use and keep for future reference



When servicing, use only identical replacement parts



CAUTION

RISK OF ELECTRIC SHOCK
DO NOT OPEN



ATTENTION

RISQUE D'ELECTROCUTION
NE PAS OUVRIR



IMPORTANT: Please read all instructions carefully before use and keep for future reference

MAJORITY

www.majorityradios.co.uk