

MAJORITY

BARD

Internet Radio
Music System



Instructions Guide

- Package contents 3**
- Overview 3**
- Getting Started 6**
- Mode Operation 9**
 - Internet Radio, Podcasts 9
 - Spotify Connect 10
 - USB Music Player 10
 - DAB+ Radio 12
 - FM Radio 13
 - Bluetooth 14
 - AUX in 14
 - Sleep 14
 - Alarm 15
- System Settings 15**
 - Equaliser 16
 - Network 16
 - Time/Date 17
 - Language 17
 - Factory Reset 17
 - Software Update 17
 - Setup Wizard 17
 - Info 18
 - Privacy Policy 18
 - Backlight 18
- Troubleshooting 18**
- Technical Specification 20**
- Disposal 22**
- Safety 22**

3 | **YEAR WARRANTY**

Register your product online for a FREE 3 year extended warranty at: www.majority.co.uk

The items enclosed in the packaging box are as follows:

Bard Music System
Power adaptor
Remote control
3.5mm audio cable
User manual

Front

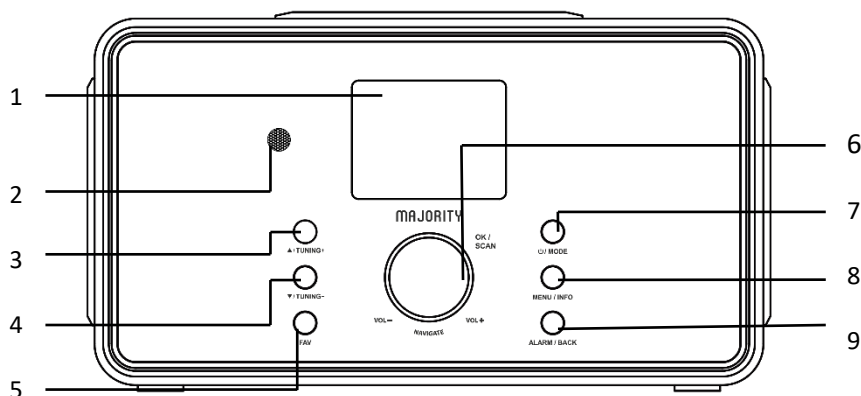

- | | | |
|---|--------------------------------|---|
| 1 | 2.4" screen | Colour TFT display |
| 2 | Remote control sensor | Receive remote control signal |
| 3 | UP/ TUNING UP button | Move up or right ; FM: Set frequency |
| 4 | DOWN / TUNING DOWN button | Move down or left / FM: Set frequency |
| 5 | FAV button | Select favourite stations ; Press and hold to BT discoverable under BT mode |
| 6 | Volume knob / OK / SCAN button | Rotate to adjust volume; Press to OK; Press to scan in FM mode |
| 7 | ON/Standby / MODE button | Switch on/Standby the device ; Enter the mode menu |

- | | | |
|---|---------------------|--|
| 8 | MENU / INFO button | Enter the menu; View the information of the station or track |
| 9 | ALARM / BACK button | Set alarm clock; Return one step under the menu |

Back

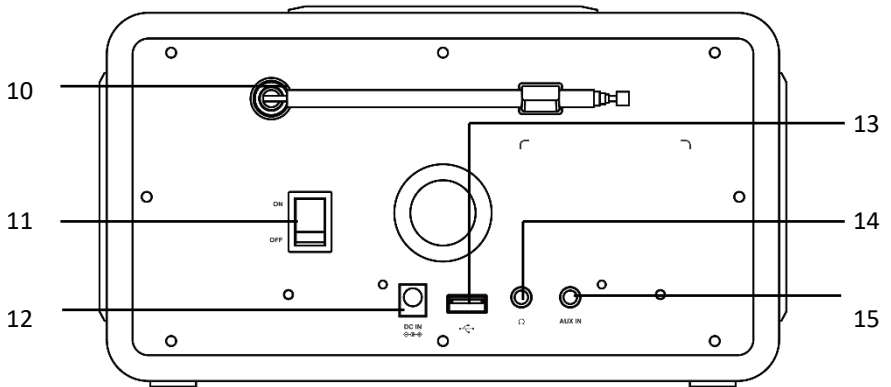

- | | | |
|----|-----------------|--|
| 10 | DAB+/FM antenna | Antenna for enhancing DAB/FM reception |
| 11 | ON/OFF switch | Switch on/off the device |
| 12 | DC IN | Plug for power support |
| 13 | USB port | USB drive music playback |
| 14 | Headphone jack | 3.5mm headphone output |
| 15 | AUX jack | 3.5mm audio input |

Remote Control

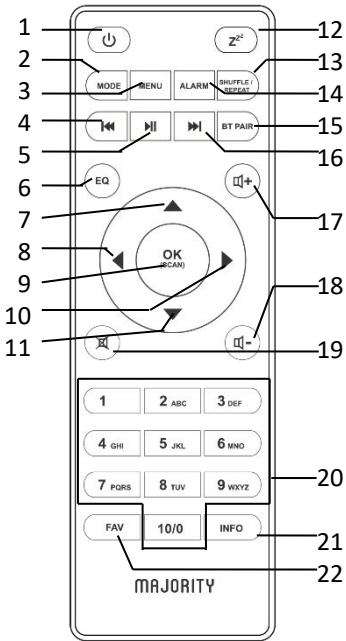

1		Device power on/off; alarm off
2	MODE	Open, close mode selection
3	MENU	Press to open, close menu
4		Select previous track, hold down to seek
5		Start playback, pause
6	EQ	Select equalizer preset
7		Move up; FM: Set frequency
8		Move left, step back
9		Confirm entry; FM: Scan; Playing: album in full screen
10		Move right, step next
11		Move down; FM: Set frequency
12		Sleep setting
13		Music: random and repeat selection
14	ALARM	Set Alarm1, Alarm2
15	BT PAIR	Press and hold to BT discoverable under BT mode
16		Select next track, hold down to seek
17		Increase volume
18		Decrease volume
19		Mute, unmute
20		Number buttons: retrieve saved favourite station, hold down to save station
21	INFO	Display FM mode info (Name, PTY, RT, frequency) Display DAB mode info (Station, track, artist etc.)
22	FAV	Select favourite stations, hold down to save favourite

Operating your remote control

Press and slide the back cover to open the battery compartment of the remote control.

Insert two AAA size batteries. Make sure the (+) and (-) ends of the batteries match the (+) and (-) ends indicated in the battery compartment.

Close the battery compartment cover.

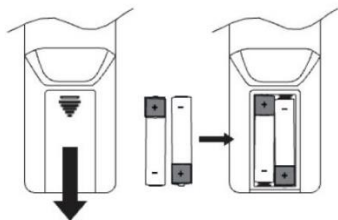

Getting Started



Connection and Preparation

Connect the power adaptor to the back of device and plug it into power socket. It starts up after switching on the device.

Connecting the network

- A broadband connection in combination with a wireless access point, router or similar network device.
- The network device needs to support WiFi (802.11 a/b/g/n) wireless connection.

Make sure you have setup the wireless network and you have the WEP, WPA or WPA2 security password to activate the connection. You may also use the WPS (WiFi Protected Setup) function for easy pairing between the network device and the radio. Check if the light indicators on the network device are in appropriate status.

Antenna

Plug the antenna to the F-connector. To get good reception for DAB/FM broadcasting, always extend the antenna with its full length.

First Time Setup

When powering the device on for the first time, first you need to set language. Selecting the menu language

Rotate the knob to select the menu language you want from the list and press OK button to confirm.

After language be chosen, it displays information of privacy policy. Press OK button to continue. Then a setup wizard appears for helping you setup the main use of the device.

Select "YES" and confirm your will launch the setup wizard.

If you select "NO", the next window will ask you choose if you want to start the setup wizard again next time you power the device on.

Setup wizard helps you setup the main use of the device.

Setting date and time - Select "12" for 12-hour display format or "24" for 24-hour display format. If you select the 12-hour format, the display shows "AM" in the morning or "PM" in the afternoon after the time.

After this, the following options are available, to define if the time to be synchronized from radios: Update from DAB, Update from FM, Update from Network or No update

If you choose "Update from Network" you must indicate your time zone in the next window.

Next choose "ON" for summer time, otherwise select "OFF".

If you choose "No update", you will have to enter the date and time manually.

"AM"/ "PM" displays only if you have chosen the 12-hour time format. Select "AM" for the morning hours or "PM" for the afternoon hours.

Setting network - Firstly the device asks if keep network connected. If you want to control the device in all operating modes via the app, select "YES". If choosing "NO", it is not possible to control the device from the app in the (Standby, AUX IN, FM, DAB) operating modes. Note that the power consumption in standby mode will be higher when the network connection is kept up.

Any WiFi networks found are listed on the display, along with their names.

After selecting the network, you will be asked for choose one of the following methods of connection:

- o Push button: The device prompts you to press the connect button on the router. It then scans for a ready Push Button Connect network and connects.

- o Pin: The device generates an 8-digit code number which you enter into the wireless router, access point, or an external registrar.

- o Skip WPS: Enter key as for a standard encrypted network. To enter the network's key, use the reel or direction buttons on the remote control to move the cursor through the characters and press OK to confirm. As each character is selected, the key is built up near the top of the display.

There are three options accessible by tuning the navigate reel back before the first characters – Backspace, OK and Cancel.

For more information on setting up a WPS encrypted network, see your WPS router's instructions.

Device attempts to connect to the selected network.

It will show connected if the setup is successful. If connecting fails, it returns to a previous screen to try again. Once completed, press OK to quit the setup wizard.

Presets

Presets are stored in the radio and cannot be accessed from other radios. Number of preset for each mode: IR and Podcasts share the same list of 40; Spotify 10; DAB 40; FM 40.

To store a preset, press and hold FAV. The display shows the Save preset screen. Select a number to save the currently playing station.

To select a preset, press FAV, then select one of the saved preset stations.

When a preset station is playing, it shows ★ (1, 2 etc.) at the bottom of the screen.

For 1-10 preset stations, there are shortcut buttons 1-10 on the remote control. Press and hold a number button to store, or press it to select, the corresponding number of preset. For a preset >10, it can only be stored or recalled via preset list.

UNDOK

The device gives a feature of network remote by smartphone or tablet in iOS or Android system. By downloading the assigned app named UNDOK, you can view all the modes the device.

Search UNDOK from Google Play or Apple Store, and install it to your smartphone or tablet.



For Android system
(Google Play)



For iOS system
(Apple Store)

Before using the UNDOK app, make sure the device and the smartphone / tablet are in the same WiFi network.

Launch the app. The app initializes and scans for Internet Radio in the network. Tap the device to make the connection.

When prompted, enter the current PIN code. The default PIN is "1234". You can view and edit the current PIN on the Internet Radio in the menu. Select your desired mode in the main page. You may then control the selected mode on your smartphone / tablet and on the display of the device simultaneously.

Tap "Standby" icon to go to the standby mode. Tap "Wake up" to go to operation mode.

Tap "Browse" to view the details. Tap  to view the saved preset stations, and tap "+" to add the playing station to the desired preset station number.

NOTE: Be aware that if another smartphone / tablet with the app in the same network have access with the device, the original connection will be cut off.

EN

Mode Operation

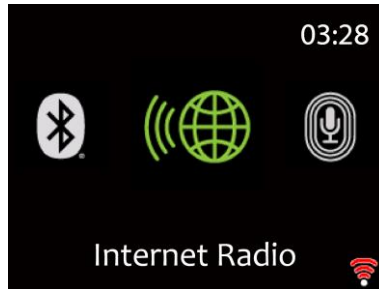

Internet Radio, Podcasts

Device can play thousands of radio stations and podcasts from around the world though a broadband Internet connection. When you select Internet radio or Podcasts mode, the device directly contacts the Frontier Smart Technologies portal to get a list of stations or podcasts. The list menu is provided from the portal, so it is only accessible when the device is connected to the Internet. The contents and submenus may change from time to time.

Choose required category and search the station or podcast to listen.

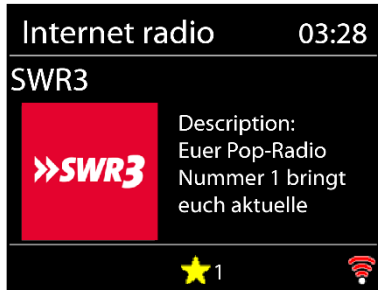

Now Playing Information

While the stream is playing, the screen shows its name and description. To view further information, press INFO.

Each time you press INFO, another set of information is displayed, cycle through name/description, genre/location, reliability, codec/sampling rate, playback buffer and today's date.

Press OK to view the station album in full screen.

Presets – 40 presets available, see section 3 (Presets).

Spotify Connect

Use your smartphone, tablet or computer as a remote control for Spotify. Go to spotify.com/connect to learn how.



The Spotify Software is subject to third party licenses found here:

<https://www.spotify.com/connect/third-partylicenses>

Start playing Spotify on your smartphone as usual. The “devices icons” is displayed at the bottom of the phone. Press it to display a list of the devices available on the network.

Now select “Majority Bard” and the playback will take place on the radio.

A successful connection is indicated by the name of the device in green text. You

can use  or  to play the previous or next track, press and hold to rewind or fast forward. Press  to play or pause.

USB Music Player

When this menu is selected, menus are generated from the folders on the USB device. Browse the folders with the navigation knob and BACK button, or direction buttons on the remote control. The display shows folders and file names (not necessarily track names).

Once you have found a track you want to play, press OK. A short press plays the track immediately.



Note: The USB port is just for music MP3 playback, it supports no charging functionality.

Supported USB file systems: FAT16, FAT32

The maximum device capacity: 128 GBytes

Maximum number of items (files/sub directories) in any directory: 5000

Maximum depth of file system tree: 8 directory levels

You can use  or  to play the previous or next track, press and hold to rewind or fast forward. Press  to play or pause.

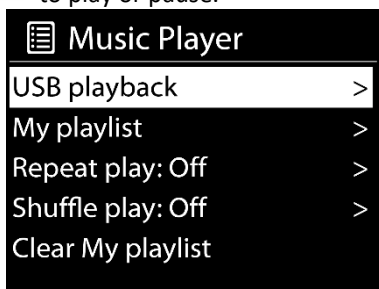

My playlist - Tracks are added to My playlist by browsing your available tracks through the USB playback menu, highlight the track you wish to add, press and hold OK to save. The playlist is preserved during standby. The device holds a queue of up to 200 tracks in My playlist.

Clear My playlist – To clear the entire “My playlist”.

Repeat/shuffle - You can set these options to repeat tracks or play them in random order. In order to activate Repeat or Shuffle press the corresponding button on the remote control.

Now playing information - While a track is playing, the screen shows its track and artist. There is also a progress bar with figures for elapsed and total track time. At the bottom of the screen, an icon indicates USB depending on the source. To view further information, press INFO. Each time you press INFO, another set of information is displayed, cycling through the information: artist, album, codec/sampling rate, playback buffer and today’s date. Album cover from USB is unsupported.

DAB Radio

DAB mode receives DAB/DAB+ digital radio and displays information about the station, stream and track playing.



Scanning for stations

The first time you select DAB radio mode, or if the station list is empty, the radio automatically performs a full scan to see what stations are available. You may also need to start a scan manually to update the list of stations for one of the following reasons:

- o Available stations change from time to time.
- o If reception was not good for the original scan, this may result in an empty or incomplete list of available stations.
- o If you have poor reception of some stations, you may wish to list only stations with good signal strength.

To start a scan manually, choose Full scan. To scan only stations with good signal strength, select Local scan.

Once the scan is complete, the radio shows a list of available stations.

To remove stations that are listed but not unavailable, choose Prune invalid.

Turn the navigate reel to view a list of stations and press OK to select. Once selected, the station plays and the screen show information about station, track or show as broadcast.

Now playing information

While the stream is playing, the screen shows its name and DLS (Dynamic Label Segment) information broadcast by the station giving real-time information such as programme name, track title and contact details. Stereo broadcasts are indicated with an icon at the top of the screen. To view further information, press INFO

.

Each time you press INFO , another set of information is displayed, cycling through DLS text, programme type, ensemble name/frequency, signal strength/error rate, bite rate/codec/channels and today's date.

Press OK to view the station album in full screen.

Presets – 40 presets available, see section 3 (Presets).

Settings

Dynamic range compression (DRC)

If you are listening to music with a high dynamic range in a noisy environment, you may wish to compress the audio dynamic range. This makes quiet sounds louder, and loud sounds quieter. You can change DRC as off, low or high.

Station order

You can choose the order of the DAB station list to be either Alphanumeric, Ensemble or Valid.

Ensemble lists groups of stations that are broadcast together on the same ensemble. Valid lists valid stations first, alphanumerically, then off-air stations.

FM Radio

FM radio mode receives analogue radio from the FM band and displays RDS (Radio Data System) information about the station and where broadcast.

To find a station, press OK. The frequency display starts to run up as the device scans the FM band. Alternatively, you can tune manually by turning the NAVIGATE knob.

Now playing information

While the stream is playing, the screen shows its frequency, or if RDS information is available, station name and any further RDS information such as programme name, track title and contact details. If no information is available, just the frequency is shown. Stereo broadcasts are indicated with an icon at the top of the screen. To view further information about the broadcast, press INFO .

Each time you press INFO, another set of information is displayed, cycling through RDS text, further RDS text (station/programme type), frequency and today's date.

Presets – 40 presets available, see section 3 (Presets).

Settings

Scan settings

By default, FM scans stop at any available station. This may result in a poor signal-to-noise ratio (hiss) from weak stations. To change the scan settings to stop only at stations with good signal strength, select Yes after choosing Strong station only?

Audio settings

All stereo stations are reproduced in stereo. For weak stations, this may result in a poor signal-to-noise ratio (hiss). To play weak stations in mono, select FM weak reception: Listen in mono only and then YES.

Bluetooth

In Bluetooth mode, the radio enters the pairing mode automatically.

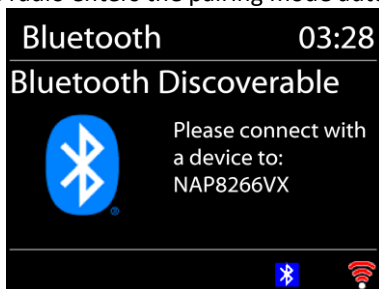

You can turn on the Bluetooth of your Bluetooth device and search the radio Majority Bard to pairing. When it is waiting for pairing, there is a blinking Bluetooth icon at the bottom. If the pairing is successful, the Bluetooth icon becomes steady.

Control the music playback from your Bluetooth device.

To disconnect from the radio, press and hold PRESET/BT PAIR, or go to the menu and choose BT disconnect.

Aux in

Aux in mode plays audio from an external source such as an MP3 player.

To play audio with Aux in mode.

Turn the volume low on both the radio and, if adjustable, the audio source device.

Connect the external audio source to the Aux in 3.5mm stereo socket.

Adjust the volume of the radio (and, if necessary, the audio source device) as required.

Sleep

To set the sleep timer, select Sleep under Main menu or press SLEEP button on the remote control. Choose from Sleep OFF, 15 30,45,60, 90 or 120 minutes. The radio will count and turn off after you select a sleep time.

Alarm

There are two versatile wake-up alarms with snooze facility, and a sleep function to turn the system off after a set period. Each alarm can be set to start in a particular mode.

Select Alarms under Main menu to set or change an alarm.

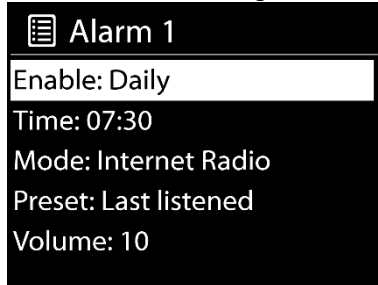

Select the alarm number (1 or 2) then configure the following parameters:

- o Enable: on/off,
- o Frequency: Daily, Once, Weekends or Weekdays,
- o Time,
- o Mode: Buzzer, Internet Radio, DAB or FM,
- o Preset: Last listened or Preset 1-40
- o Volume

To activate the new settings, scroll down and select Save.

The screen shows active alarms with an icon at the bottom left.

At the set time, the alarm will sound. To temporarily silence, press any buttons except STANDBY. You can change the snooze period. The radio returns to standby for the set period, with the silenced alarm icon flashing.

Press STANDBY to turn off the alarm.



System Settings

On the playing screen of any modes, press and hold MENU / INFO on the unit or press MENU on the remote control, choose System settings to continue.

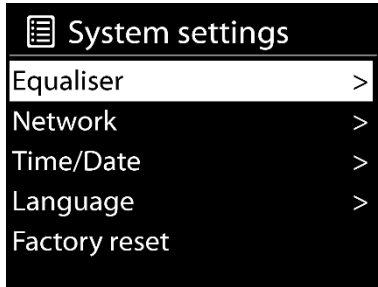

Equaliser

Several preset EQ modes are available: Normal, Flat, Jazz, Rock, Movie, Classic, Pop and News.

Also a user-defined setting is available; create your own EQ with custom bass, treble settings.

Network

Network wizard - Enter to search AP SSID, then input the WEP / WPA key or choose Push Button/Pin/Skip WPS to connect to the wireless network.

PBC WLAN setup - Push Button Configuration, it is to connect the AP that supports WPS (Wi-Fi Protected Setup).

View settings - View the information of current connected network: Active connection, MAC address, WLAN region, DHCP, SSID, IP address, Subnet mask, Gateway address, Primary DNS and Secondary DNS.

Manual settings - Choose wired or wireless network connection and enable or disable DHCP (Dynamic Host Configuration Protocol).

NetRemote PIN Setup - Here you can view and edit the NetRemote PIN. The default NetRemote PIN is: 1234. The NetRemote PIN is required when you want to connect a smartphone or Tablet PC to your radio.

Network profile - The smart radio remembers the last four wireless networks it has connected to, and automatically tries to connect to whichever one of them it can find.

From here you can see the list of registered networks. You can delete unwanted networks by pressing OK button and then choosing "YES" to confirm delete.

Clear network settings - Select "YES" to clear all the current network settings. Select "NO" to cancel.

Keep network connected - If you choose to keep network connected the WiFi will not disconnect even in standby mode. This option allows the device to be ready for UNDOK (Details can be found on Section 3) connection in any operating modes.

Time/Date

Set the time manually or auto update, time format, time zone and daylight. Details can be referred to Setting date and time under to Section 3 (First Time Setup).

Language

The default language is English. Change it as your preference. There are 13 languages available - English, Dansk, Deutsch, Español, Français, Italiano, Nederlands, Norsk, Polski, Português, Suomi, Svenska, Türkçe

Factory Reset

A factory reset resets all user settings to default values, so that time and date, network configuration and presets will be lost.

Software Update

Auto-check setting - This option automatically checks for new updates from time to time. Automatic updating is enabled by default. To disable it, select “NO”. To enable it again, select “YES”.

Check now - Search for available updates immediately.

If newer available software is detected, you will be asked if you want to go ahead with an update. If you agree, the new software is then downloaded and installed. After a software upgrade, all user settings are maintained.

NOTE: Before starting a software upgrade, ensure that the radio is plugged into a stable main power connection. Disconnecting power during an upgrade may permanently damage the unit.

Setup Wizard

With this function, you can start the setup wizard at any time. Any parameters or stations entered already are not deleted. For more information, please read the Section 3 (First-time setup).

Info

Enter Info to view the firmware version and the radio ID.

Privacy Policy

View the information of Privacy Policy. Please read the data protection regulations listed there or go to this website: www.frontiersmart.com/privacy

Backlight

You may change the backlight of each environment (power on or standby) to High, Medium or Low. And adjust the timeout duration which the radio turns to standby backlight level when it has not been controlled.

Troubleshooting



Error	Remedy
The device does not switch on or turned off suddenly.	<ol style="list-style-type: none">1. Check if the power adaptor is connected properly.2. The device may malfunction when used in areas with strong radio interference. The device will work properly again once there is no more interference.
No Power	Ensure that the power adaptor plug of the unit is connected properly.
No Sound or lower sound	<ol style="list-style-type: none">1. Tune on the sound as it may be muted.2. Increase the volume.
No network connection can be established.	<ol style="list-style-type: none">1. Check the WLAN function.2. Try to set an IP address at the device.3. Activate the DHCP function on the router and make the connection again at the device.4. A firewall is activated on the network – set the respective program in such a way that access is possible.5. Reboot the router.
WiFi connection cannot be established.	<ol style="list-style-type: none">1. Check the availability of WLAN network on the router.

	<ol style="list-style-type: none"> 2. Place the device closer to the router. 3. Make sure the password is correct.
No station is found.	<ol style="list-style-type: none"> 1. Check the network as well as the access point and firewall. 2. The station may not be available currently, try again later. 3. The link of the station is changed or the station no longer transmits – ask the provider for information. 4. The link of manual added station may not be correct, check and change it.
No signal or hiss in DAB/FM mode.	<ol style="list-style-type: none"> 1. Check the antenna installation properly/move the antenna. Also try to adjust the length of antenna. 2. Move the radio to other location.
USB driver or MP3 player is not detected.	<ol style="list-style-type: none"> 1. Check if the USB driver or MP3 player is plugged properly. 2. Some USB hard disks need external power supply, make sure it is connected to the power. 3. Not all MP3 players can be read directly on the device – use an USB drive instead.
Alarm does not work.	<ol style="list-style-type: none"> 1. Switch on the alarm. 2. Due to the volume setting, refer to the solutions of “No sound”. 3. The source of alarm was set to be station but there is no network connection. Change the source of alarm or reconfigure the connection.
All other undetermined cases. / Electro-Magnetic Interference.	<p>The smart radio may process large amount of data after a period of operation, no matter in which mode, it will cause the system freeze or malfunction.</p> <p>Reboot the device if necessary.</p>
	<p>The normal function of the product may be disturbed by strong Electro-Magnetic Interference. If so, simply reset the product to resume normal operation by following the instruction manual. In case the function could not resume, please use the product in other location.</p> <p>The device may malfunction when used in areas with strong radio interference. The device will work properly again once there is no more interference.</p>

Technical Specification



Model number	Majority Bard
Description	Internet Radio Music System
Speaker output power	100W
Display	2.4", 320 x 240, colour TFT display
FM	87.5 – 108.0 MHz, RDS supported
DAB/DAB+	174 – 240 MHz (Band III)
Power adaptor	15.0V $\overline{=}$ 2.4A \diamond $\overline{=}$ \diamond 36.0W
Connections	AUX in (3.5mm socket) Headphone (3.5mm socket) USB (type A) - for playback only, no charging function DC IN power supply (5.5mm socket)
Network standby power	<2.0W
Max. power consumption	36.0W
Operating temperature	0 °C - 35 °C
Dimensions	235mm(L) x 129mm(H) x 135mm(D)
Weight	2.1 kg

Specifications subject to change without notice.

Power Adaptor	
Manufacturer's name	Dongguan Green Power One Co., Ltd.
Address	No.26, Hongyun Street, Chonghe Village, Qingxi Town, Dongguan City, P.R, China
Model no.	GA361-1502400E, GA361-1502400B
Input voltage	100 – 240V ~ AC, 50/60Hz, 1.2A
Output voltage	DC 15.0V
Output current	2.4 A
Output power	36.0 W
Average active efficiency	89.73%
Efficiency at low load (10%)	88.95%
No-load power consumption	0.07W

This device has been approved for compliance with the basic and other relevant requirements of the RE Directive 2014/53/EU, the ErP Directive 2009/125/EC



Disposal



- If have to dispose the device in the future, note that all electrical and electronic device must be disposed of separately from household waste at official disposal centres.
- Avoid damage to the environment and risks to your personal health by disposing of device properly.
- For further information about proper disposal, contact your local government, disposal bodies or the shop where you bought the device.
- Dispose of all packaging in an environmentally -friendly manner.
- Cardboard packaging can be taken to paper recycling containers or public collection points for recycling.
- Any film or plastic contained in the packaging should be taken to your public collection points for disposal.
- Respect the environment. Old batteries must not be disposed of with domestic waste. They must be handed in at a collection point for waste batteries. Please note that batteries must be disposed of fully discharged at appropriate collection points for old batteries. If disposing of batteries which are not fully discharged, take precautions to prevent short circuits.



Safety



General

- Do not drop the device and do not expose it to liquid, moisture or humidity. These might lead to damage to the device.
- If the device is moved from a cold environment into a warmer one, do let it adapt to the new temperature before operate the device. Otherwise, it might lead to condensation and cause malfunctions in the device.
- Do not use the device in the dust environment as dust can damage the interior electronic components and lead to malfunctions in the device.
- The device is in indoor use only.
- Protect the device from strong vibrations and place it on stable surfaces.
- Do not attempt to disassembly the device.
- If the device is not using for a long period of time, disconnect it from the power supply by unplugging the power plug. This is to avoid the risk of fire.
- The ventilation should not be impeded by covering the ventilation openings with items, such as newspapers, table-cloths, curtains, etc.

- No naked flame sources, such as lighted candles, should be placed on the apparatus.

Power adaptor

- Only use the power adaptor delivered with the device.
- The socket outlet should be installed near the device and should be easily accessible.
- Never touch the power plug with wet hands and never pull on the power cable when pulling the plug out of the power socket.
- Make sure the electrical voltage specified on the device and its power plug is corresponding to the voltage of the power socket. Incorrect voltage will destroy the device.



Risks associated with high volumes

- Listening the device with headphones, always reduce the volume before put on the headphones. After the headphones are positioned properly, increase the volume to the desired level.
- To prevent possible hearing damage, do not listen at high volume for long periods.



Maintenance / Cleaning

- Always power off the unit when cleaning it.
- Never use any harsh or strong solvents to clean the device since these may damage the surface of the device. Dry, soft cloth is appropriate, however, if the device is extremely dirty, it may be wiped off with a slightly moist cloth. Make sure the device is dried off after cleaning.
- When you are necessary to ship the device, store it in its original package. Save the package for this purpose.

MAJORITY

www.majority.co.uk