

# TETON

USER MANUAL

MAJORITY

---

HOME AUDIO • CAMBRIDGE

Contents.....	2
Controls & Functions.....	3
Box Contents.....	5
Additional Info .....	6
Mode Indicator Lights & Audio Settings .....	7
USB Input .....	8
RCA Input .....	9
ARC Input .....	10
Optical Input.....	11
AUX/Line In Input.....	12
Connecting to the Power Outlet.....	13
Bluetooth .....	14
Troubleshooting.....	15
Spec, Support & Warranty.....	16
Regulatory Information.....	17
Safety Information.....	18

**3** | YEAR  
WARRANTY

Register your product online for a **FREE** 3 year  
extended warranty at: [www.majority.co.uk](http://www.majority.co.uk)

## FRONT, SIDE, AND REAR VIEW

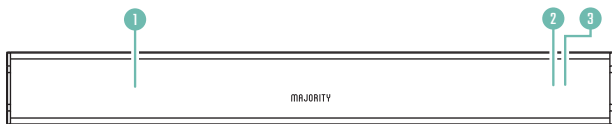

1. **Speaker drivers**
2. **Remote control sensor**
3. **LED Indicator Light**

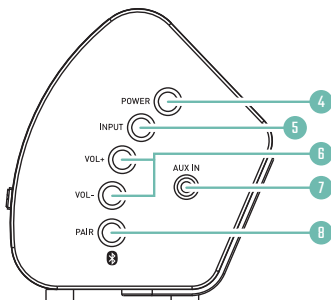

4. **On/Off**
5. **Change mode (BT, OPTICAL, AUX, RCA, USB, ARC).**
6. **Adjust volume**
7. **AUX in socket**
8. **Bluetooth pair button**

9. **USB socket**
10. **RCA socket**
11. **ARC/HDMI in socket**
12. **OPTICAL in socket**
13. **DC 18V socket**

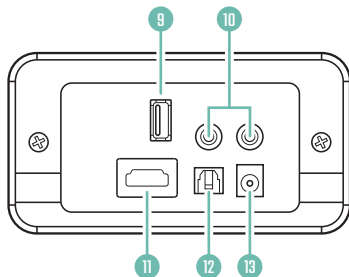

## REMOTE CONTROL

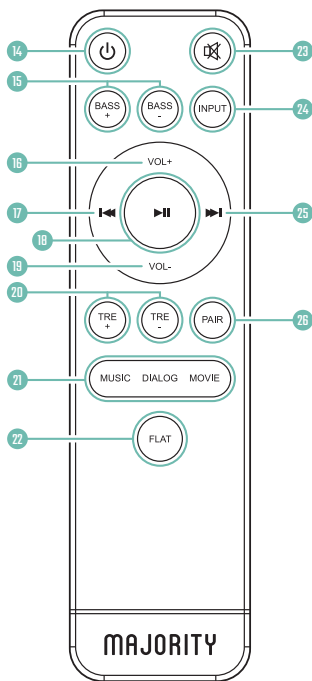

14. Power on/off
15. Bass increase/decrease
16. Volume +
17. Back: Use in Bluetooth and USB modes to go back a track.
18. Play/Pause: In Bluetooth/USB mode, press to pause/play media.
19. Volume -
20. Treble increase/decrease
21. Media modes: Select Music, Dialogue or Movie EQ mode
22. Flat: Press to reset EQ settings to default
23. Mute/Unmute
24. Input: Press to switch between modes
25. Forward Step: Use in Bluetooth/USB mode to go forward a track.
26. Pair: Press to connect/disconnect from a Bluetooth device

## WHAT'S IN THE BOX?

- A. Majority Teton Soundbar
- B. Remote Control
- C. 3.5mm to 3.5mm Audio cable
- D. RCA Stereo Audio Cable
- E. Power Adapter

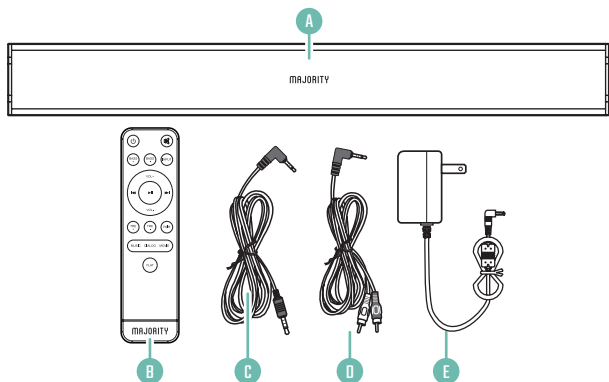

Note: Remote control (B) requires 2 x AAA batteries (not included). It is recommended to use alkaline or heavy duty batteries as this will ensure a longer playtime.

### **Automatic Power Off Function**

The Majority Teton will automatically go to standby mode after 180 minutes if the connected TV is switched off, or if there is any audio signal in.

### **Wall mounting**

The Majority Teton can be mounted to a wall using the appropriate fittings for your wall type by using the wall mounting brackets positioned at the rear of the unit. As these differ between wall types the fittings are not included. To wall mount the Teton soundbar, the appropriate fittings for your application will need to be sourced.

## MODE INDICATOR LIGHTS

State	Indicator Lights
Power off	Red
AUX mode	Green
USB mode	Purple
RCA mode	White
ARC mode	Light blue
Optical mode	Yellow
Bluetooth ready	Flashing blue
Bluetooth connected	Blue

## AUDIO SETTINGS

Mode	Bass/Treble Options Db (decibels) refers to sound level.
MUSIC	Manually change BASS and TREBLE settings (between 0Db and +8Db).
DIALOG	BASS+ BASS- TRE+ TRE- functions are disabled
MOVIE	BASS+ BASS- TRE+ TRE- functions disabled
FLAT	Restore to default settings and manually change BASS and TRE settings between -8Db and +8Db

## USING THE USB INPUT

1. Connect your USB device to the USB jack (Ref.9) on the soundbar.
2. Press the 'INPUT' button (Ref.24) on the remote, and the LED indicator will be Purple.
3. Play music files from the USB device through the soundbar.

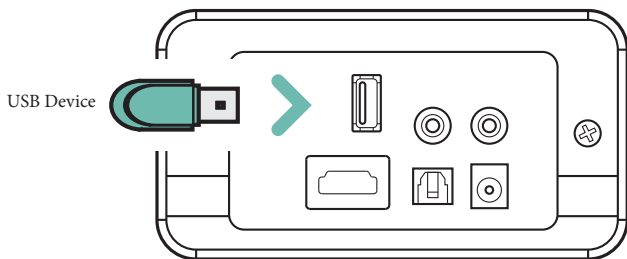

Rear panel of soundbar



## USING THE RCA INPUT

Use the RCA Stereo Audio Cable to connect the TV's stereo RCA(L/R) audio output socket to the RCA(L/R) Sockets of the unit (Ref.10).

Then press the INPUT button on the remote control (Ref.24) or press the INPUT button on the soundbar (Ref.5) to choose the AUX function.

**Troubleshooting:** If you are not receiving a picture or encountering interference, please ensure that the RCA cable is being connected to 'output' RCA ports on your TV set. This will ensure that the sound is being exported correctly.

If your TV does not have 'output' RCA ports, please use an alternative connection method.

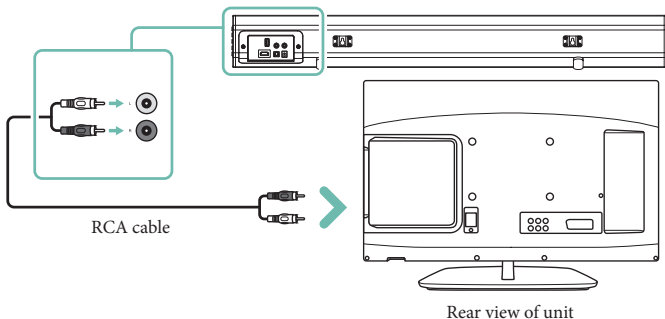

## USING THE ARC (HDMI) INPUT

Connect the HDMI cable (included) to the HDMI ARC connector on the back of the unit to the HDMI (ARC) connector on the TV.

**NOTE:** In the HDMI ARC mode, if your speakers have no audio output and the indicator light is flashing quickly, use your source device (such as a TV, CD player, or cable/satellite receiver). The audio output mode is set to PCM, or turn off the sound source output.

The transmission of digital audio signals between devices is not workable for all the TV brands in the markets because the branded TVs are not cross-brand compatibility to each other.

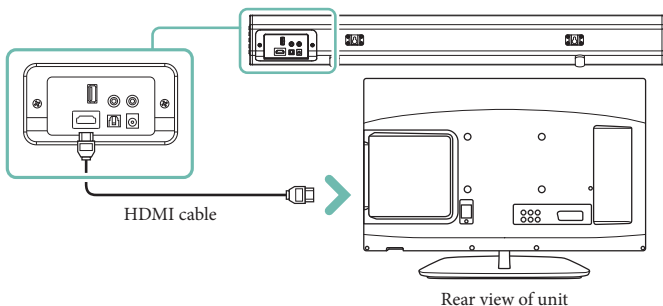

## USING THE OPTICAL INPUT

You will need: An audio source with an Optical Audio Output and a Digital Optical Audio cable (included).

Connect the Digital Optical Audio cable to the optical output on the audio source and to the Optical Input on the soundbar (Ref.12).

Press the POWER button on the side panel (Ref.4) or on the remote control (Ref.14) to switch on the unit.

Press the INPUT button on the remote control repeatedly (Ref.24) to switch to Optical mode or press the INPUT button (Ref.5) repeatedly on the soundbar to select Optical mode. The mode indicator LED will turn yellow.

Using the native controls on your connected device, make sure the audio settings are set to PCM or Optical Audio and are switched on.

Audio from the connected audio source will now be played through the speakers.

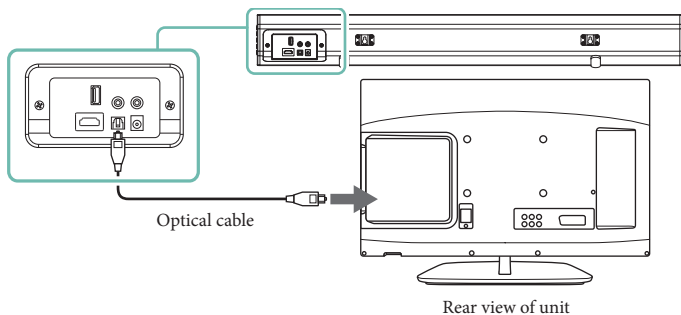

## USING THE MP3 LINK CONNECTION (AUX IN)

Plug one end of a 3.5mm audio input cable (included) into the Line in (Ref.7) on the unit. Before use, disconnect any cables connected to the Stereo RCA Inputs.

Plug the other end of the cable into the audio output/ headphone output on an MP3 player or other audio source.

Press the POWER button on the side panel (Ref.4) or on the remote control (Ref.11) to switch on the unit.

Press the INPUT button repeatedly on the soundbar (Ref.5) or press INPUT on the remote control (Ref.24) repeatedly until LINE in mode is selected. The mode indicator will turn green.

Audio played through the connected device will now be heard through the speakers.

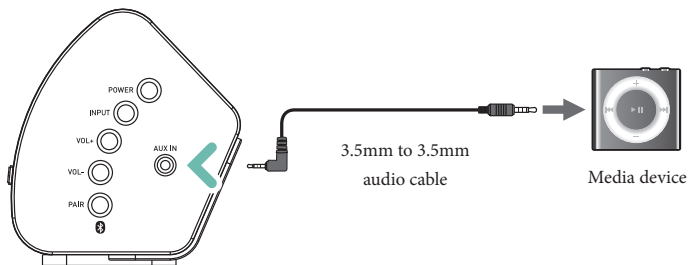

## CONNECTING TO THE MAINS SUPPLY

Ensure that the power supply voltage is within the range of 100V~240V. Any other voltage may cause damage to the unit.

Unwind the mains cable to its full length. Connect the mains plug to a mains socket.

Ensure that the mains plug is fully inserted into the mains socket.

The mains plug/appliance coupler is used as the disconnect device. The disconnect device must remain readily operable.

Connect the adapter into the soundbar AC Socket (Ref.13).

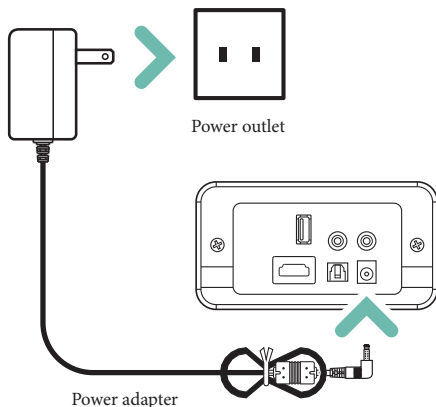

Ensure all audio connections of the unit are connected before connecting to the mains power socket. Unplug the power cord from the outlet when the unit is used for an extended period of time.

## BLUETOOTH OPERATION

### Pairing a Bluetooth Device for the First Time

Press the **POWER** button on the soundbar (Ref.4) or on the remote control (Ref.14) to switch on the unit.

Press the **INPUT** button repeatedly on the remote control (Ref.24) or press the **INPUT** button on the soundbar (Ref.5) repeatedly until Bluetooth mode is selected (indicated by a flashing blue light).

From your Bluetooth device, select the "Majority Teton" when prompted to choose a Bluetooth device.

If a password is required, enter "0000". If you encounter issues at this stage, please refer to the user manual for your Bluetooth device for instructions on pairing and connecting Bluetooth devices.

When successfully connected, a beep will issue from the unit and a solid blue light will be displayed. After initial pairing, the unit will stay paired unless manually unpaired by the user, or until the device is reset.

If your device should become unpaired or you find it is unable to connect, repeat the above steps.

## TROUBLESHOOTING

If you encounter an issue with your soundbar, please refer to the following checklist.

Observation	Potential Cause/Solution
No power/function	<p>Check that the power is switched on at the wall.</p> <p>Check that the power adaptor is properly connected to the power outlet.</p>
No sound	<p>Check whether the unit is set to MUTE.</p> <p>Check that cables are properly installed. If cables are properly installed, please try connecting to your TV using an alternative cable.</p> <p>Check unit is switched on and in correct mode.</p>
No sound in Bluetooth mode	<p>Check that your Bluetooth device is paired.</p> <p>Check that you have pressed the PAIR button before pairing.</p> <p>Check whether external device requires password "0000".</p>
Function disturbance	<p>Switch off and unplug the unit. Leave for 2 minutes and switch on again.</p> <p>If a particular mode is causing problems, please try an alternative connection to your TV such as Optical or Bluetooth.</p>
Remote control function issues	<p>Check whether the battery needs replacing, and replace if necessary.</p> <p>Check whether there are obstacles blocking the remote sensor.</p>
No sound when connected and switched to OPTICAL IN mode	<p>Check and ensure the audio setting of the input source (e.g. TV, games console, DVD player, etc) is set to PCM mode while using digital connection (such as Optical, HDMI and COAXIAL).</p>

## SPECIFICATION

Power Supply	DC 18V 1.5A
Frequency Response	30Hz-20KHz
SNR	70dB
Separation	45dB
Bluetooth	V5.0
Dimension (WxHxD)	81.2 x 9.6 x 10.2cm
Net Weight	1.5kg

## SUPPORT

If you require further assistance with your new soundbar, please contact our support team on the Majority website: [www.majority.co.uk/support](http://www.majority.co.uk/support)

## WARRANTY

All products come with a standard 12 month warranty. All items must be registered on [www.majority.co.uk](http://www.majority.co.uk) for the warranty to be valid. Once on the web page, use the menu to find "Register Your Product". You will also be given the chance to extend your warranty for an additional 24 months, free of charge.



**NOTE:** This equipment has been tested and found to comply with the limits for a Class B digital device, pursuant to part 15 of the FCC Rules. These limits are designed to provide reasonable protection against harmful interference in a residential installation. This equipment generates, uses and can radiate radio frequency energy and, if not installed and used in accordance with the instructions, may cause harmful interference to radio communications. However, there is no guarantee that interference will not occur in a particular installation. If this equipment does cause harmful interference to radio or television reception, which can be determined by turning the equipment off and on, the user is encouraged to try to correct the interference by one or more of the following measures:

- Reorient or relocate the receiving antenna.
- Increase the separation between the equipment and receiver.
- Connect the equipment into an outlet on a circuit different from that to which the receiver is connected.
- Consult the dealer or an experienced radio/TV technician for help.

**Warning:** Changes or modifications to this unit not expressly approved by the party responsible for compliance could void the user's authority to operate the equipment.

### **FCC Radiation Exposure Statement**

The device has been evaluated to meet general RF exposure requirements. The device can be used in Fixed/mobile (min20cm) exposure conditions without restriction.

1. Read these instructions.
2. Keep these instructions. Instructions are also available for download at [www.majority.co.uk](http://www.majority.co.uk)
3. Heed all Warnings
4. Follow all instructions
5. Do not clean the apparatus near or with water
6. Do not block any ventilation openings. Install in accordance with the manufacturer's instructions
7. Do not install near any heat sources such as radiators, heat registers, stoves, or other apparatus (including amplifiers) that produce heat.
8. Protect the power from being walked on or pinched particularly at plugs, convenience receptacles, and the point where they exit from the apparatus.
9. Only use attachments/accessories specified by the manufacturer.
10. Unplug this apparatus during light storms or when unused for long periods of time.
11. Refer all servicing to qualified service personnel. Servicing is required when the apparatus has been damaged in a way, such as power-supply cord or plug is damaged, liquid has been spilled or objects have fallen into the apparatus, the apparatus has been exposed to the rain or moisture, does not operate normally or has been dropped.
12. No naked flame sources, such as lit candles, should be placed on the apparatus.
13. Dispose of used electrical products and batteries safely according to your local authority and regulations.

#### ADDITIONAL WARNINGS

The apparatus shall not be exposed to dripping or splashing and no objects filled with liquid, such as vases, shall be placed on the apparatus.

Main plug is used to disconnect device and it should remain readily operable during intended use. In order to disconnect the apparatus from the main mains completely, the mains plug should be disconnected from the main socket outlet completely.

Battery shall not be exposed to excessive heat such as sunshine, fire or the like.

#### RECYCLING ELECTRICAL PRODUCTS

 You should now recycle your waste electrical goods and in doing so help the environment. This symbol means an electrical product should not be disposed of with normal household waste.

Please ensure it is taken to a suitable facility for disposal when finished with.

**IMPORTANT:** Please read all instructions carefully before use and keep for future reference.

 Risk of electric shock.  
Do not open

 Read all instructions carefully before use and keep for future reference

 When servicing, use only identical replacement parts



#### CAUTION

RISK OF ELECTRIC SHOCK  
DO NOT OPEN



#### ATTENTION

RISQUE D'ELECTROCUTION  
NE PAS OUVRIR



**IMPORTANT:** Please read all instructions carefully before use and keep for future reference

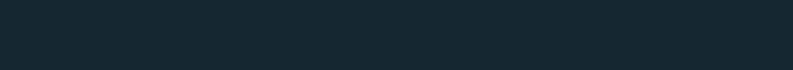

# MAJORITY

HOME AUDIO • CAMBRIDGE

[WWW.MAJORITY.CO.UK](http://WWW.MAJORITY.CO.UK)